

Model GXR Series

Triplex
Plunger Pump
Operating Instructions/
Repair Instructions
Manual

Consumer Pump

Horizontal/Vertical Pump
with built-in Regulator,
Thermal Relief Valve and
Siphon Injector

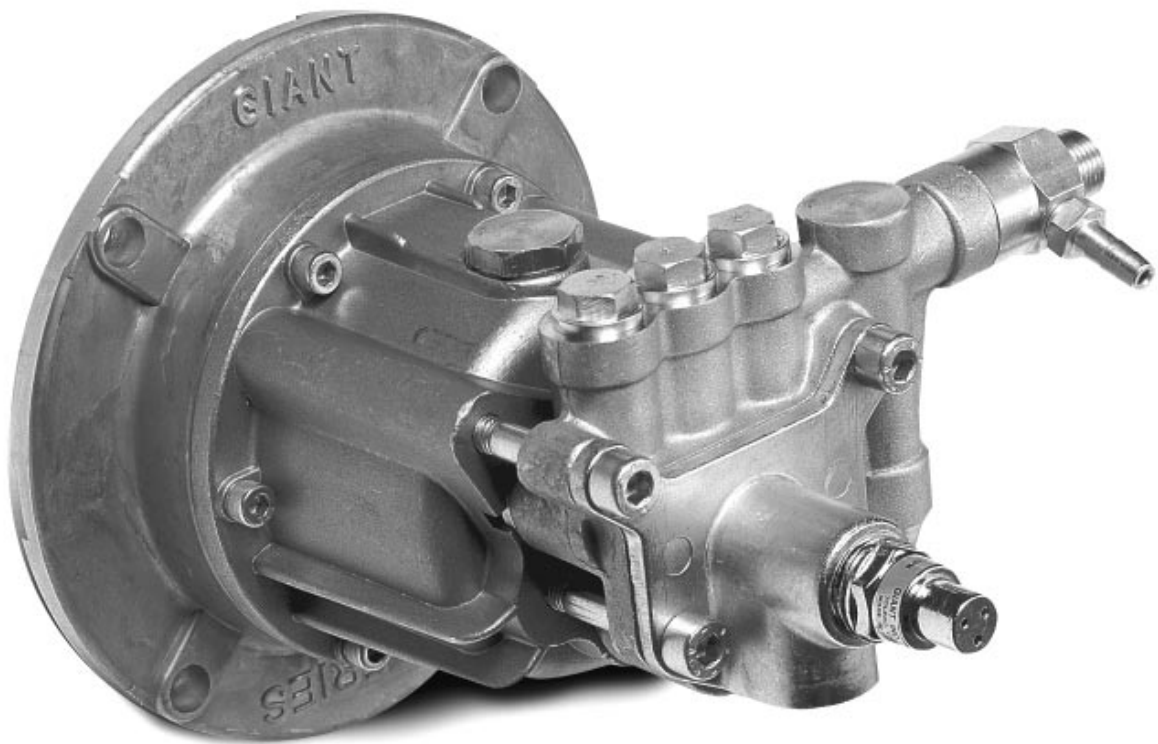

Updated 8/01

Contents:

Installation Instructions:	page 2
Pump Specifications:	page 3
Exploded View/Kits:	page 4
Parts List:	page 5
Torque Specifications:	page 5
Repair Instructions:	pages 6-7
Dimensions:	back page
Warranty Information:	back page

INSTALLATION INSTRUCTIONS

Installation of the Giant Industries, Inc., pump is not a complicated procedure, but there are some basic steps common to all pumps. The following information is to be considered as a general outline for installation. If you have unique requirements, please contact Giant Industries, Inc. or your local distributor for assistance.

1. For horizontal applications the pump should be installed flat on a base to a maximum of a 15 degree angle of inclination to ensure optimum lubrication.
2. The inlet to the pump should be sized for the flow rate of the pump with no unnecessary restrictions that can cause cavitation. Teflon tape should be used to seal all joints. Maximum inlet fluid temperature is 80°F.
3. The discharge plumbing from the pump should be properly sized to the flow rate to prevent line pressure loss to the work area. It is essential to provide a safety bypass valve between the pump and the work area to protect the pump from pressure spikes in the event of a blockage or the use of a shut-off gun.
4. Use of a dampener is necessary to minimize pulsation at drive elements, plumbing, connections, and other system areas. The use of a dampener with Giant Industries, Inc. pumps is optional, although recommended by Giant Industries, Inc. to further reduce system pulsation. Dampeners can also reduce the severity of pressure spikes that occur in systems using a shut-off gun. A dampener must be positioned downstream from the regulator.
6. Before beginning operation of your pumping system, remember: Check that the crankcase and seal areas have been properly lubricated per recommended schedules. Do not run the pump dry for extended periods of time. Cavitation will result in severe damage. Always remember to check that all plumbing valves are open and that pumped media can flow freely to the inlet of the pump.

Finally, remember that high pressure operation in a pump system has many advantages. But, if it is used carelessly and without regard to its potential hazard, it can cause serious injury.

IMPORTANT OPERATING CONDITIONS

Failure to comply with any of these conditions invalidates the warranty.

1. Prior to initial operation, Check for proper oil level. **DO NOT OVERFILL.**

Use Giant Synthetic Oil

Crankcase oil should be changed after the first 50 hours of operation, then at regular intervals of 500 hours or less depending on operating conditions.

2. Pump operation must not exceed rated pressure, volume, or RPM. A pressure relief device must be installed in the discharge of the system.
3. Acids, alkalines, or abrasive fluids cannot be pumped unless approval in writing is obtained before operation from Giant Industries, Inc.
4. Run the pump dry approximately 10 seconds to drain the water before exposure to freezing temperatures.

Specifications

Model GXR Series

GXR2224	2.2 GPM @ 2400 PSI
GXR2424	2.4 GPM @ 2400 PSI
Maximum Inlet Pressure	Up to 90 PSIG ¹
RPM	3450
Plunger Diameter	16mm
Stroke GXR2224	4.7mm (6.1 ° angle)
Stroke GXR2424	5.1mm (6.3 ° angle)
Crankcase Oil Capacity	4.7 fl. oz. (4.1 fl.oz. horizontal)
Temperature of Pumped Fluids	Up to 80 °F
Inlet Port	1/2" NPT
Discharge Ports	3/8" NPT
Shaft Rotation	Either Direction ²
Weight	9 lbs.
Width	8.325"
Height	6.45"
Swash Plate Bore (Horizontal)	3/4" x 3/16" Keyway
Swash Plate Bore (Vertical)	7/8" x 3/16" Keyway
Valve Type	Polyamide Plastic

- ¹ A 25 PSIG minimum inlet pressure is required.
- ² The pump itself can be driven in either direction of rotation; however, the cooling fan on TEFC motors must always be positioned so that the cooling air is drawn from the non-drive end of the motor towards the pump.

GXR2224 ELECTRIC HORSEPOWER REQUIREMENTS					
RPM	GPM	1000 PSI	1500 PSI	2000 PSI	2500 PSI
3450	2.2	1.5	2.3	3.0	3.8

GXR2224 GAS ENGINE HORSEPOWER REQUIREMENTS*					
RPM	GPM	1000 PSI	1500 PSI	2000 PSI	2500 PSI
3450	2.2	2.0	3.0	4.0	5.0

GXR2424 ELECTRIC HORSEPOWER REQUIREMENTS					
RPM	GPM	1000PSI	1500PSI	2000PSI	2400 PSI
3450	2.4	1.6	2.5	3.3	3.9

GXR2424 GAS ENGINE HORSEPOWER REQUIREMENTS*					
RPM	GPM	1000PSI	1500PSI	2000PSI	2400 PSI
3450	2.4	2.2	3.3	4.4	5.2

HORSEPOWER RATINGS:

The rating shown are the power requirements for the pump. Gas engine power outputs must be approximately twice the pump power requirements shown above.

We recommend a 1.15 service factor be specified when selecting an electric motor as the power source. To compute specific pump horsepower requirements, use the Following formula:

$$\text{Electric HP} = (\text{GPM} \times \text{PSI}) / 1460$$

$$\text{Gas HP} = (\text{GPM} \times \text{PSI}) / 1100$$

* Engine power varies based on horizontal or vertical orientation as well as by makes and model from each manufacturer.

GXR SERIES EXPLODED VIEW

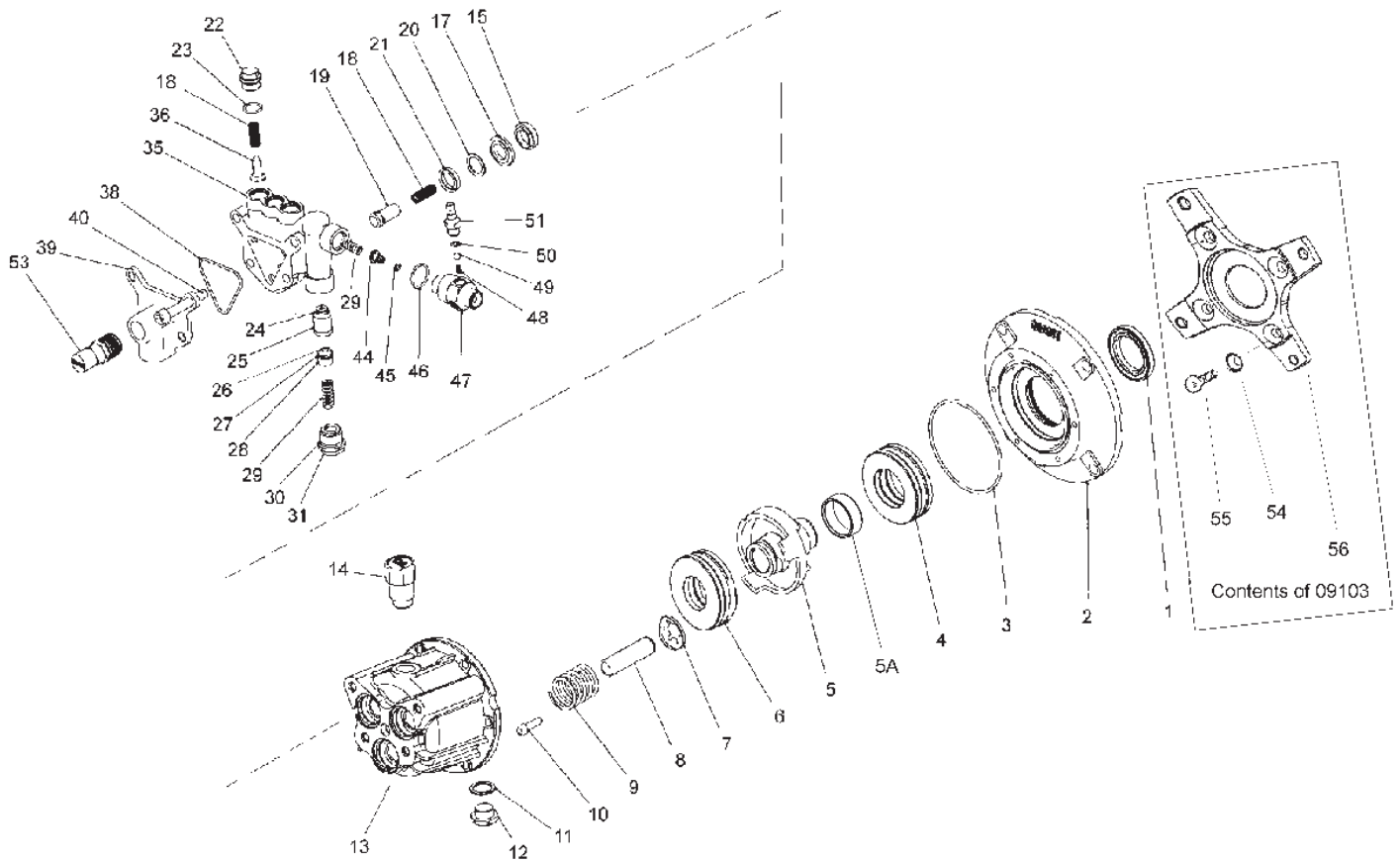

Plunger Packing Kit # 09465

Item	Part #	Description	Qty.
20	06290	Support Ring	3
21	06315	V-Sleeve	3

Oil Seal Kit # 09468

Item	Part #	Description	Qty.
15	06316	Plunger Oil Seal	3

Valve Assembly Kit # 09466

Item	Part #	Description	Qty.
18	07374	Valve Spring	6
19	06267	Guided P-Valve	3
36	06295	Discharge Valve Cone	3

Regulator Repair Kit # 09534

Item	Part #	Description	Qty.
24	23507	O-Ring	1
25	06710	Seat	1
26	06386	Ball	1
27	06385	O-Ring	1
28	06384	Plastic Poppet Valve	1
30	06410	O-Ring	1

GXR SERIES PARTS LIST

ITEM#	Part#	Description	QTY.	ITEM#	Part#	Description	QTY.
1	07805	Radial Shaft Seal	1	23	12007	O-Ring	3
2	06310*	Adapting Flange	1	24	23507	O-Ring	1
3	06294	O-Ring	1	25	06710	Seat	1
4	06300	Rear Bearing	1	26	06386	6mm S.S. Ball	1
5	06690**	Wobble Plate 6.1 Degree 3/4" (GXRH1114)	1	27	06385	O-Ring	1
5	06566**	Wobble Plate 6.3 Degree 3/4" (GXRH2424)	1	28	06384	Plastic Poppet Valve	1
5	06696+	Wobble Plate 6.1 Degree 7/8" (GXRV2224)	1	29	06382	Spring	1
5	06322+	Wobble Plate 6.3 Degree 7/8" (GXRV2424)	1	30	06410	O-Ring	1
5A	07882	Shaft Ring	1	31	06392	Cap	1
6	06301	Front Bearing	1	35	06412	Manifold	1
7	06289	Spring Disk	3	36	06295	Discharge Valve Cone	3
8	06287	Plunger, 16mm	3	38	07910A	Triangle O-Ring	1
9	06288	Plunger Spring	3	39	06298	Suction Flange	1
10	06299	Socket Bolt	6	40	06302	Stud Bolt	4
11	08192	Gasket	1	44 ^A	06308	Orifice, 1.8mm	1
12	06273	Oil Drain Plug	1	44 ^A	06339	Orifice, 2.1mm	1
13	06282	Crankcase (GXRV)	1	44 ^A	06340	Orifice, 2.3mm	1
13	06338	Crankcase (GXRH)	1	45	06312	O-Ring in Nozzle	1
14	08083	Vent Cap (Horizontal Only)	1	46	07913	O-Ring	1
15	06316	Oil Seal	3	47	06303	Injector Retainer	1
17	06292	Spacer	3	48	23009	Spring	1
18	07374	Valve Spring	6	49	23010-0100	Ball	1
19	06267	Guided P-Valve	3	50	12516-0001	O-Ring	1
20	06290	Pressure Ring	3	51	12517	Hose Barb	1
21	06315	V-Sleeve, 16mm	3	53	23422A	Thermal Relief Valve	1
22	06296	Discharge Plug	3	54 ⁺⁺	07468	Locktooth Washer	4
				55 ⁺⁺	07467	Screws	4
				56 ⁺⁺	06334	Mounting Flange "X" Style	1

** 09103 Gasoline Flange Kit

A = See pump numbering system page 7

* When ordering 06310, please order 17026, which includes 06300, 07805, and 06294.

** When ordering 06566, please order 17047 which includes 06566, 06301, and 07882.

** When ordering 06690, please order 17052 which includes 06690, 06301, and 07882.

+ When ordering 06322, please order 17027 which includes 06322, 06301, and 07882.

+ When ordering 06691, please order 17053 which includes 06691, 06301, and 07882.

GXR SERIES TORQUE SPECIFICATIONS

<u>Position</u>	<u>Item#</u>	<u>Description</u>	<u>Torque Amount (ft.-lbs)</u>
10	06299	Socket Bolt	100 in.-lbs.
40	06302	Stud Bolt	150 in.-lbs.

REPAIR INSTRUCTION - GXR SERIES



1. With a 14mm socket wrench, remove the three discharge valve plugs (27). Inspect the valve plug o-rings (23) for wear, and replace as necessary.

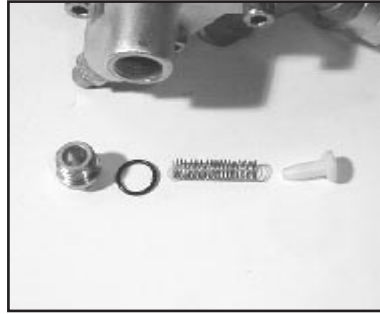

2. Remove the valve spring (18) and valve cone (36) from the manifold (35). Inspect the parts for wear and replace as necessary.

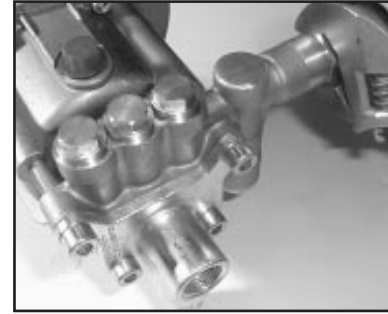

3. With a crescent wrench, remove the injector retainer (47). Inspect the o-ring (46) for wear and replace as necessary.



8. Next, remove the four manifold bolts (40) with a 6mm allen wrench.

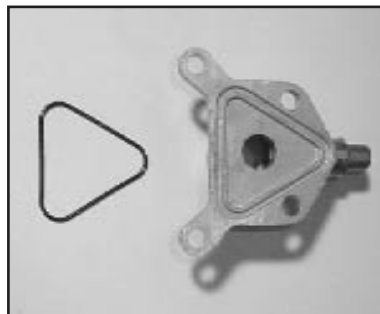

9. Remove the suction flange (39) and flange o-ring (38). Inspect the o-ring for wear and replace as necessary.



10. Tap the back of the manifold (35) with a rubber mallet to dislodge, and slide off the plungers. (8). Take note of the position of the discharge port so as to place the manifold in the same position during reassembly.

GXR SERIES REPAIR INSTRUCTIONS

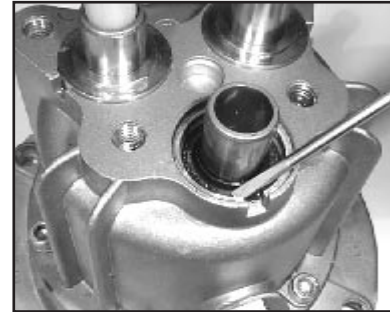
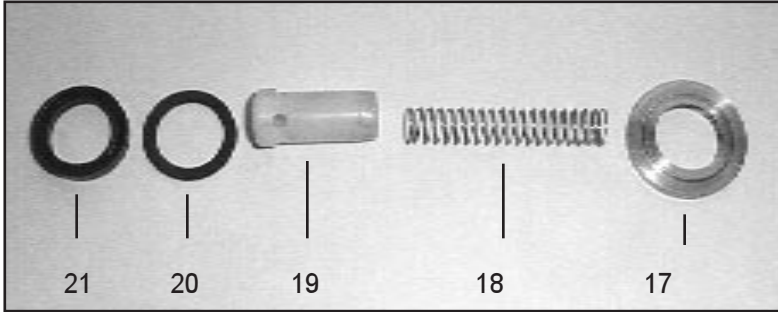

11. Remove the guided p-valve, (19), valve springs (18), v-sleeves (21) and pressure rings (20). Inspect for wear and replace as necessary. Remove the spacer ring (17) from the plungers (8).

12. If the crankcase oil seals (15) are to be replaced, they can be removed by prying loose with a screwdriver. Take care not to make contact with the plunger (8) and pry out the oil seals from their housing. Seals should not be reinstalled until after step #16.

13. Reassemble in reverse order. Fill the crankcase with the proper amount of oil (see specifications page 3) The pump is now ready for operation.

For maintenance of the gear end of your pump, contact your local distributor or Giant Industries at: 419/531-4600

**NOTE: Contact Giant Industries for Service School Information.
Phone: (419)-531-4600**

GX and HR Pump Part Numbering System

GX or HR Series	Flow	Pressure (in 100 psi increments)		Injector Size	Thermal Relief Valve	Wobble Plate Shaft Bore
Vertical	20=GPM	25=2500 PSI		1=2.1 mm	1=1/2"	1=3/4"
Horizontal	23=GPM			2=1.8mm		2=7/8"
	25=GPM			3=2.3mm		3=1"
						4=5/8"
GX or HR	2.5	25	-	1	1	1

For example, a GXV2525-112 is a GX pump that produces 2.5 GPM @ 2500 PSI, has a injector with a 2.1mm Oriface, 1/2" thermal relief valve and 7/8" wobble plate bore.

GXR Series Dimensions (inches)

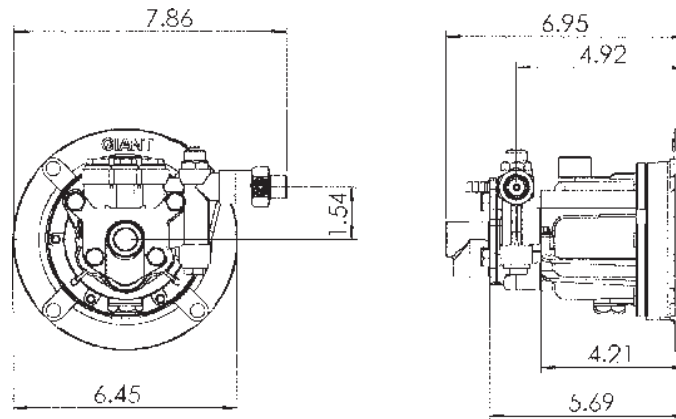

GIANT INDUSTRIES LIMITED WARRANTY

Giant Industries, Inc. pumps and accessories are warranted by the manufacturer to be free from defects in workmanship and material as follows:

1. For portable pressure washers and self-service car wash applications, the discharge manifolds are guaranteed for the life of the pump. Our other pump parts, used in portable pressure washers and in car wash applications, are warranted for five years from the date of shipment for all pumps used in NON-SALINE, clean water applications.
2. One (1) year from the date of shipment for all other Giant industrial and consumer pumps.
3. Six (6) months from the date of shipment for all rebuilt pumps.
4. Ninety (90) days from the date of shipment for all Giant accessories.

This warranty is limited to repair or replacement of pumps and accessories of which the manufacturer's evaluation shows were defective at the time of shipment by the manufacturer. The following items are NOT covered or will void the warranty:

1. Defects caused by negligence or fault of the buyer or third party.
2. Normal wear and tear to standard wear parts.
3. Use of repair parts other than those manufactured or authorized by Giant.
4. Improper use of the product as a component part.
5. Changes or modifications made by the customer or third party.
6. The operation of pumps and or accessories exceeding the specifications set forth in the Operations Manuals provided by Giant Industries, Inc.

Liability under this warranty is on all non-wear parts and limited to the replacement or repair of those products returned freight prepaid to Giant Industries which are deemed to be defective due to workmanship or failure of material. A Returned Goods Authorization (R.G.A.) number and completed warranty evaluation form is required prior to the return to Giant Industries of all products under warranty consideration. Call (419)-531-4600 or fax (419)-531-6836 to obtain an R.G.A. number.

Repair or replacement of defective products as provided is the sole and exclusive remedy provided hereunder and the MANUFACTURER SHALL NOT BE LIABLE FOR FURTHER LOSS, DAMAGES, OR EXPENSES, INCLUDING INCIDENTAL AND CONSEQUENTIAL DAMAGES DIRECTLY OR INDIRECTLY ARISING FROM THE SALE OR USE OF THIS PRODUCT.

THE LIMITED WARRANTY SET FORTH HEREIN IS IN LIEU OF ALL OTHER WARRANTIES OR REPRESENTATION, EXPRESS OR IMPLIED, INCLUDING WITHOUT LIMITATION ANY WARRANTIES OR MERCHANTABILITY OR FITNESS FOR A PARTICULAR PURPOSE AND ALL SUCH WARRANTIES ARE HEREBY DISCLAIMED AND EXCLUDED BY THE MANUFACTURER.