

FEATURES

- Forged brass manifold with exclusive lifetime warranty
- High flow applications
- Dual manifolds utilizing a common crankcase for efficient performance
- Solid ceramic plungers with continuously lubricated packings
- Unitized stainless steel inlet and discharge valves
- Bronze connecting rods for maximum life

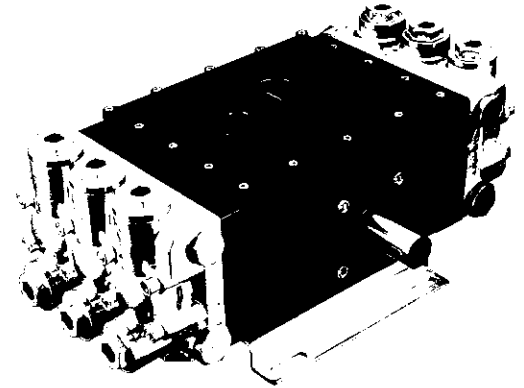

SPECIFICATIONS

Pump Model	T121	T151
Maximum Volume	35.0 GPM	43.0 GPM
Maximum Discharge Pressure	1000 PSI	
Maximum Pump Speed	650 RPM	
Maximum Inlet Pressure	125 PSI	
Maximum Inlet Vacuum	9 ft. water (7.9 in. Hg)	
Bore	1.772 in. / 45 mm	
Stroke (in./mm)	.945 / 24	1.102 / 28
Crankcase Oil Capacity	71 oz.	
Maximum Fluid Temperature	165°F	
Inlet Port Thread	1-11 BSPP-F	
Discharge Port Thread	3/4-14 BSPP-F	
Shaft Diameter.	1.378 in. / 35 mm	
Weight	156 lbs.	
Dimensions	22.1 x 14.0 x 9.7 in.	

DIMENSIONAL DRAWING

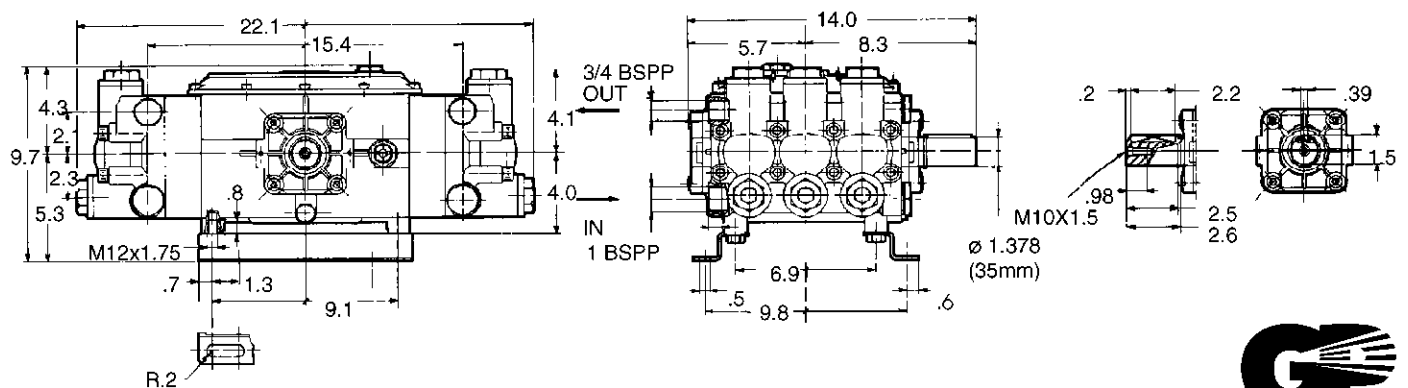

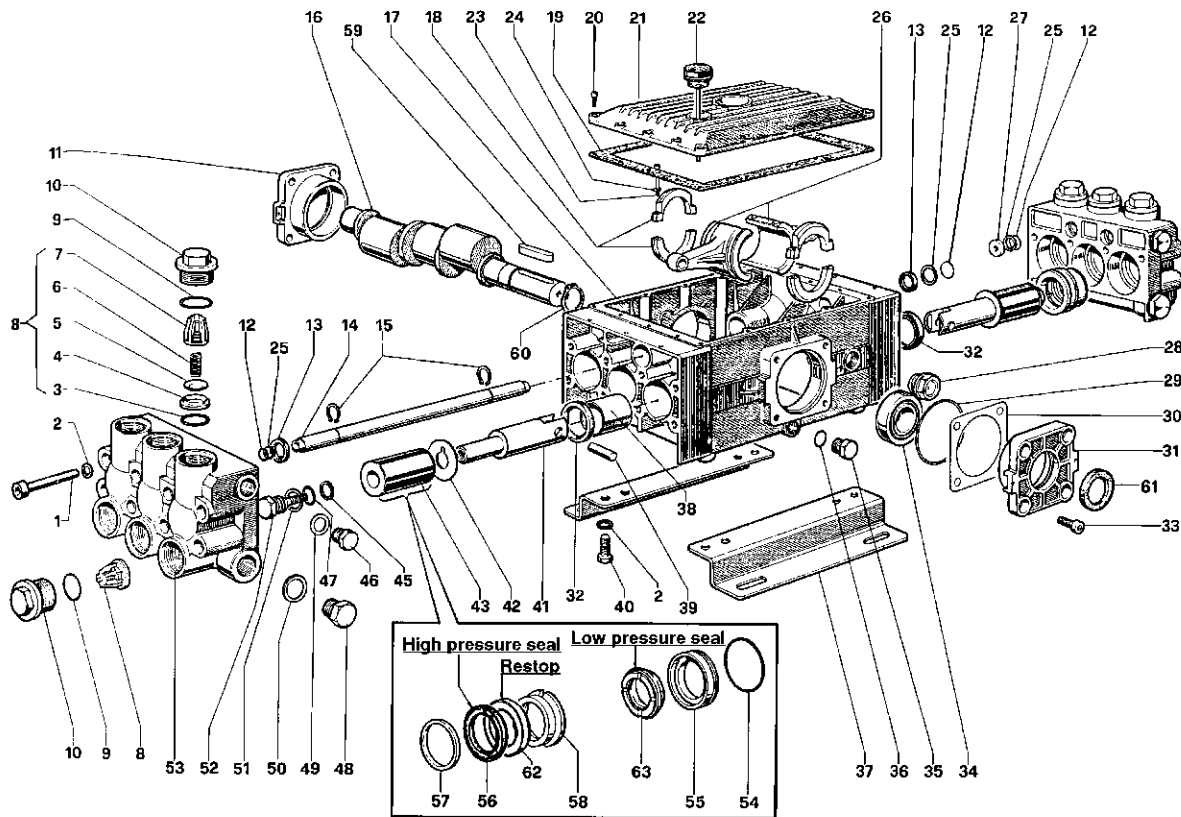

PARTS LIST

ITEM PART NO.	DESCRIPTION	KIT NO.	QTY.	ITEM PART NO.	DESCRIPTION	KIT NO.	QTY.	ITEM PART NO.	DESCRIPTION	KIT NO.	QTY.
1.	99.4418.00 Screw		16	21.	77.2114.22 Cover		1	42.	96.7568.00 Washer		6
2.	96.7195.00 Washer		20	22.	98.2272.00 Oil Dip Stick		1	43.	76.0402.09 Plunger (45 mm)		6
3.	90.4059.00 O-Ring	43	12	23.	99.1927.00 Screw		12	45.	90.5107.00 Anti-Ext. Ring	74	6
4.	36.2011.66 Valve Seat	43	12	24.	96.6938.00 Washer		12	46.	98.2265.00 Cap		3
5.	36.2010.76 Valve	43	12	25.	90.5091.00 Anti-Ext. Ring		4	47.	90.3841.00 O-Ring	74	6
6.	94.7450.00 Spring	43	12	26.	77.0302.41 Connecting Rod		3	48.	98.2325.00 Cap		2
7.	36.2009.51 Valve Guide	43	12	27.	77.2203.70 Cap		2	49.	96.7700.00 Washer		3
8.	36.7065.01 Valve Unit	43	12	28.	97.5968.00 Oil Indicator		1	50.	96.7870.00 Washer		2
9.	90.4065.00 O-Ring		12	29.	90.4141.00 O-Ring		2	51.	96.7555.00 Washer	74	6
10.	98.2420.00 Cap		12	30.	76.2200.78 Shim		2	52.	69.2195.66 Plunger Bolt	74	6
11.	76.1501.22 Cover		1	31.	76.1500.22 Crankcase		1	53.	77.1200.41 Manifold		2
12.	90.3835.00 O-Ring		4	32.	90.1670.00 Ring	44	6	54.	90.3903.00 O-Ring	47, 80	6
13.	90.1614.00 Ring		4	33.	99.3652.00 Screw		8	55.	76.0802.70 Packing Retainer	47, 80	6
14.	77.2122.93 Head Conn. Tube		1	34.	91.8474.00 Bearing		2	56.	90.2850.00 Packing	79, 80	6
15.	90.0605.00 Cir-Clip		2	35.	98.2100.00 Cap		1	57.	76.1002.51 Head Ring	48, 80	6
16.	76.0211.35 Crankshaft (T121)		1	36.	90.3833.00 O-Ring		1	58.	76.2170.70 Intermed. Ring	80, 81	6
	76.0210.35 Crankshaft (T151)		1	37.	76.2000.74 Foot		2	59.	91.4978.00 Key		1
17.	77.0100.22 Crankcase		1	38.	90.9174.00 Bushing		6	60.	90.0695.00 Cir-Clip		1
18.	77.2120.01 Ring		6	39.	97.7400.00 Plunger Pin		6	61.	90.1672.00 Ring	32	1
19.	77.2118.84 Gasket		1	40.	99.4266.00 Screw		4	62.	90.2848.00 Ring	79, 80, 81	6
20.	99.1867.00 Screw		16	41.	77.0500.54 Plunger Guide		6	63.	90.2855.00 Seal, Low Press., 45mm	79, 80	6

REPAIR KITS

KIT NO.	32	43	44	47	48	74	79	80	81
ITEM NO.s INCLUDED IN KIT	61	3, 4, 5, 6, 7 (8)	32	54, 55	57	45, 47, 51, 52	56, 62, 63	54, 55, 56, 57, 58, 62, 63	58, 62
NUMBER OF ASSEMBLIES IN KIT	2	6	3	3	6	3	3	1	3
NUMBER OF CYLINDERS KIT WILL SERVICE	-	6	3	6	3	3	3	1	1

TORQUE SPECS*

Position	Ft.-lbs.
1	51.5
10	95.8
20	7.3
23	8.8
28	13.2
33	29.4
40	51.5
46	51.5
48	73.7
52	29.4

*Decrease torque by 20% if threads are lubricated.

